

HX210A L HX210A NL

With EU Stage V Engine installed

* Photo may include optional equipment.



Head Office(Sales Office)
14F, GLOBAL R&D CENTER, 477 BUNDANG SUSEO-RO, BUNDANG-GU, SEONGNAM-SI, GYEONGGI-DO, 13553, KOREA

PLEASE CONTACT

Gross Power
129 kW (173 hp) at 2,200 rpm

Net Power
127 kW (170 hp) at 2,200 rpm

Bucket Capacity
0.80 ~ 1.34m³

Operating Weight
HX210A L 22,150kg / 48,830lb
HX210A NL 22,800kg / 50,270lb

WHAT'S NEWEST AND BEST

HX210A L
HX210A NL

THE BEST PRODUCTIVITY AND FUEL EFFICIENCY

- EU STAGE V Engine **NEW**
- Eco Report **NEW**
- EPFC System **NEW**
- Lifting Mode **NEW**
- Fuel Rate Information
- Eco Gauge
- Automatic Engine Shut Down

ULTIMATE DURABILITY

- Side Protector **Option**
- ROPS / FOG Cabin
- Reinforced Durability of Upper and Lower Structure and Attachments
- Durable Cooling Module

EASY CONTROL AND COMFORTABLE OPERATION

- Key On Init Work Mode **NEW**
- Visibility and Handle Improvement **NEW**
- One Pedal Travel Straight **Option**
- Proportional Auxiliary Hydraulic System **Option**
- 2 way Proportional RCV & Pedal control selection **Option**
- Fine(Cushion/Free) Swing Control **Option**
- Intelligent & Wide Cluster
- Jog Dial Module
- OME(Owner Menu Editing)
- Combination Speed

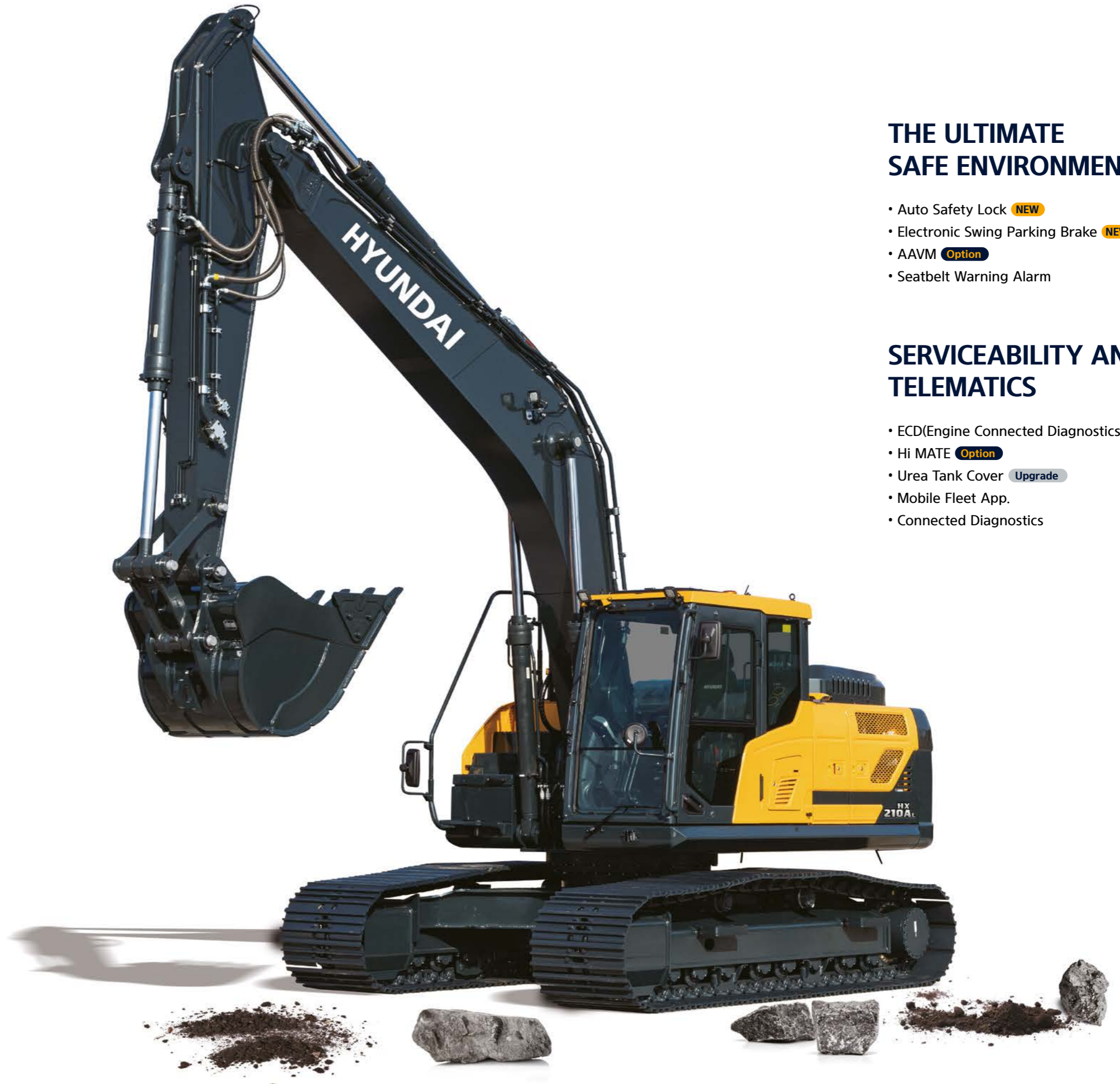

THE ULTIMATE SAFE ENVIRONMENT

- Auto Safety Lock **NEW**
- Electronic Swing Parking Brake **NEW**
- AAVM **Option**
- Seatbelt Warning Alarm

SERVICEABILITY AND TELEMATICS

- ECD(Engine Connected Diagnostics) **NEW**
- Hi MATE **Option**
- Urea Tank Cover **Upgrade**
- Mobile Fleet App.
- Connected Diagnostics



THE BEST PRODUCTIVITY AND FUEL EFFICIENCY

HX A Series is equipped with eco-friendly, high-performance engines that meet the EU Stage V emission requirements.



ENVIRONMENTALLY FRIENDLY FUEL EFFICIENCY

Eco Report **NEW**

It reports the excavator's inefficient operation status and help improving operator's working habit.



Fuel Rate Information

Fuel information is displayed as average rate and latest fuel consumed for guiding to economy operating.



Eco Gauge

Gauge level changes in accordance with engine working load and color indicates fuel saving-operation status.



Automatic Engine Shut Down

Adjustable 'Automatic engine shut down' significantly reduces idle time. Overall operating hours and fuel consumption.



EU STAGE V CERTIFIED ENGINE

Cummins B4.5 engine is satisfying the most strict environmental emission regulation in the world. (Reduction in PM 60%)

EU STAGE V Engine **NEW**

Now in its fourth decade of continuous improvement, the B4.5 for 2019 features an EGR-free design that delivers 5 percent more power and 31 percent more peak torque than the current model. Increased fuel economy and longer maintenance intervals contribute to a reduced cost of operation.

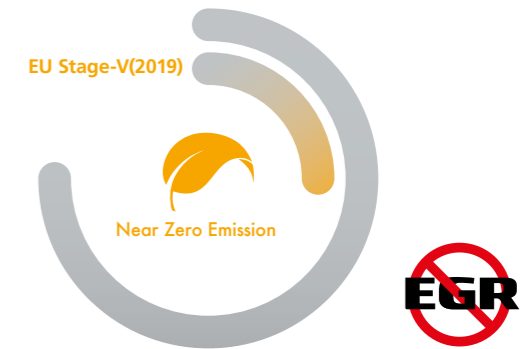

EPFC System(Electric Positive Flow Control) **NEW**

The advanced hydraulic system and controls based on electric positive flow control system achieve the lowest fuel consumption and improved fine control. Pump power is precisely variable controlled through recognition of lever manipulation amount and specific complex operations.

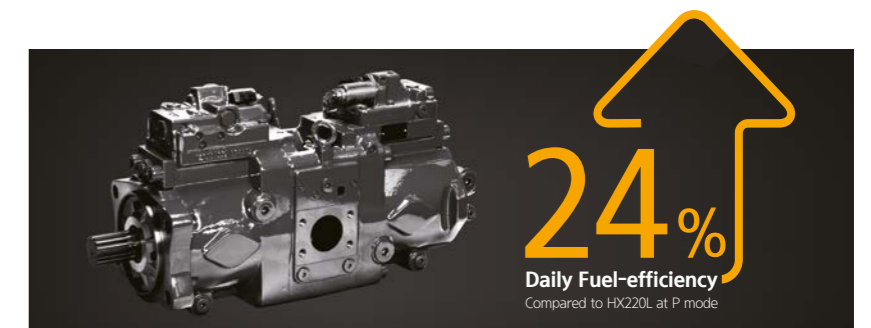

Lifting Mode **NEW**

This work mode improves fine operability and lift capability through RPM reduction, power boost activation and pump flow control.

* Photo may include optional equipment.



ULTIMATE DURABILITY

The true value of HX A Series lies in its durability and high productivity. The robust upper and lower frame structure can endure external shock and heavy work loads. Attachment performance has been proven through rigorous field testing. No matter how tough the working environment is, you can always rely on the HYUNDAI Excavator A Series.



We make the best performance in rough working conditions without any unsureness with trustworthy HX210A NL.



HX A Series is equipment with eco-friendly, high-performance engines that meet the EU Stage V emission requirement. Become a true leader on the ground with HX A Series.

ROPS / FOG Cabin

The cabin structure of Hyundai HX A Series is using integrally welded low-stress, high strength steel to meet ROPS and FOG certification.

- ROPS : Roll-Over Protective Structures ISO12117-2
- FOG : Falling Object Guard, ISO10262 Level2



Reinforced Durability of Upper and Lower Structure and Attachments

The upper and lower structure and attachments of HX A Series have higher durability than demanded on the site, as proven through numerous tests including road tests and virtual simulation. The wear resistance of the bucket has been improved by use of new material.



Durable Cooling Module

HX A Series has a durable cooling module that passed stringent tests, demonstrating the highest productivity in tough working environments.

Side Protector Option

Protect sides frame during operation in narrow area



* The shape of the camera and Lamp guard may be changed to improve the performance of the equipment.

13%

CABIN SPACE FOR DRIVERS INCREASED BY
(Compared to the previous model)



310mm
340mm

EASY CONTROL AND COMFORTABLE OPERATION

Many electronic functions are concentrated in the most convenient spot for operators to improve work efficiency. The highly-advanced infotainment system, a product of HCE's intensive information technology development, enables both productivity and comfort while working! HX A Series is designed with the operator in mind.

Intelligent & Wide Cluster

The 8" capacitive-type display (like smartphone display) of HX A Series is delivering excellent legibility. The centralized switches on the display allow convenience of checking the urea level and temperature outside the cabin.

One Pedal Travel Straight Option

One Pedal straight Travel is available for customers' convenience when long distance traveling or combination of attachment work with traveling is necessary.



Proportional Auxiliary Hydraulic System Option

Proportional control switch with better speed control helps operators to enlarge the operation convenience whenever they do time-consuming work. And this function can be switched with pedal valve in cluster setting menu. Newly added detent function allows an operator to continue using 2 way piping flow even if the operator does not keep pressing proportional control switch.

* The arrangement of switches can be changed to increase customer convenience.

Jog Dial Module

The integrated jog dial module applies to the accelerator, remote air conditioner controller and operation of the cluster, allowing convenient operation. In the event of failure of the jog dial module, the emergency mode is activated on the cluster to ensure fail-safe function.



Key On Init Work Mode NEW

Operator can maintain previously set about attachment mode when starting.



Visibility and Handle Improvement NEW

Visibility through cabin door is improved and handle design on the cabin door is also improved and offers better convenient while operator get on and off the cabin.



OME (Owner Menu Editing)

The Owner of machine can restrict operators access the set of functions. In the menu, Owner can set the list of the function to lock or unlock it. It is necessary to input the password to access the set of function.

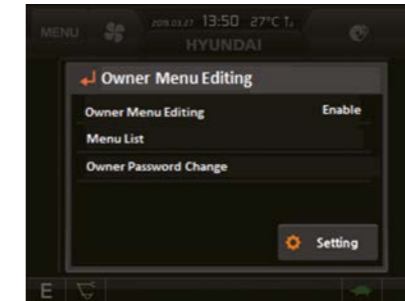

Combination Speed

Operator can set load sensitivity level, boom priority level against arm and swing. Load sensitivity is controlled by 5 levels of initial flow rate for boom-up and arm in operation according to attachment weight. Boom priority against arm and swing can be set 10 levels of boom priority against arm and swing.

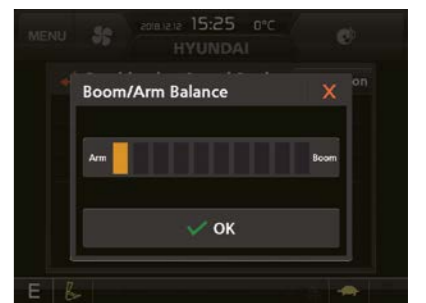
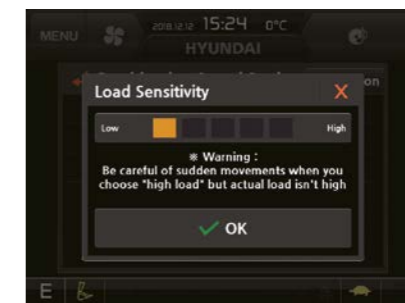

Fine (Cushion/Free) Swing Control Option

This option enables smooth movement at the start and stop of swing operation (Cushion Swing). In addition, it reduces the shaking of the weight when lifting operation (Free Swing).

// HX210A L, HX210A NL with advanced technology ensures our safety on a construction site. //



HX A Series excavators are products of HCE's spirit of initiative, creativity, and strong drive. HCE engineers, who are the best in the industry, have worked tirelessly to offer a zero-defect product. The new HX A Series reflects customers' needs in the field gleaned by thorough monitoring.

AAVM(Advanced Around View Monitoring) Camera System Option

HX A Series has a state-of-the-art AAVM video camera system to secure field of vision for operators in all directions, thereby preventing accidents. Operators can easily check the workplace in the front and rear and to the right and left.

- **AAVM**(Advanced Around View Monitoring) : Secure field of vision in all directions by nine views including 3D bird's eye view and 2D/4CH view.
- **IMOD**(Intelligent Moving Object Detection) : Inform when people or dangerous objects are detected within the range of operation(recognition distance : 5 m).

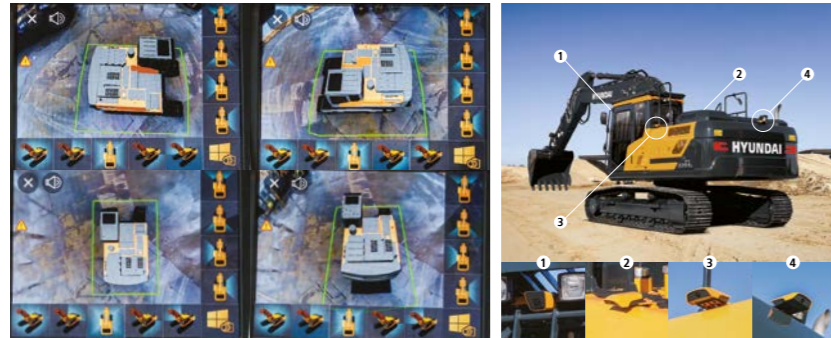

* The shape of the camera and Lamp guard may be changed to improve the performance of the equipment.

Auto Safety Lock NEW

It prevents unintended operation. If operator unlock safety lever when RCV lever is pressed, excavator is not controlled by RCV lever.

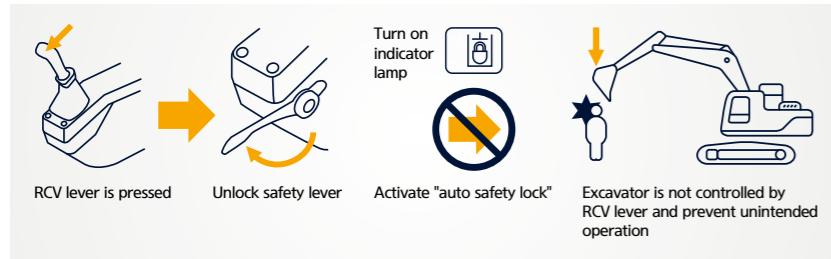

Seatbelt Warning Alarm

If the seatbelt is not buckled when the ignition key is turned, an alarm is triggered in intervals along with a continuous visual alert. This emphasises our priority for operator safety.

Electronic Swing Parking System NEW

An electronic valve and control system is applied to improve safety and utilization. The opening and closing time of the swing brake valve is controlled according to the sensing and control system.



THE ULTIMATE SAFE ENVIRONMENT

The true value of HX A Series lies in its durability. The robust frame structure and the attachments show the real value of HX A Series in tough working environments and promise higher productivity.

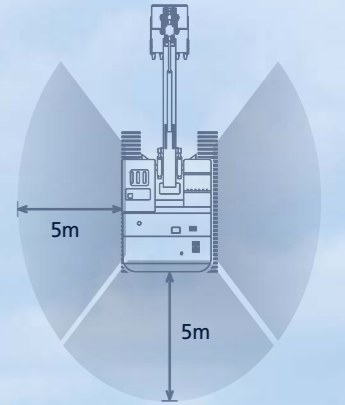

*Photo may include optional equipment.



SERVICEABILITY AND TELEMATICS

IoT / ICT / AI-based digital technology. Creating a smart construction site. Maximizes connectivity, productivity, and safety for successful businesses.



HiMATE

Option

IT'S CONVENIENT, EASY AND VALUABLE

Hi MATE Hyundai's newly developed remote management system, utilizes GPS-satellite technology to provide customers with the highest level of service and product support available. Hi MATE enables users to remotely evaluate machine performance, access diagnostic information, and verify machine locations at the touch of a button.

WHAT IS BENEFITS



Increase Productivity

It helps you operate machines in efficient. You can check the difference between total engine hours and actual working hours. See how productive your machines are and plan any required cost saving solutions. Hi MATE offers working information such as working / idling hours, fuel consumption and rate.



Convenient and Easy Monitoring

There is nothing much to do to monitor your machines. Just log on to the Hi MATE website or mobile application. Hi MATE allows you to watch your machines whenever and wherever you are.



Security

Protect your machines from theft or unauthorized usage with Hi MATE. If the machine moves out of the Geo-fence boundary, you will get alerts.

*Photo may include optional equipment.

ECD(Engine Connected Diagnostics) **NEW**

It supports service technician with remote diagnostics report and ensure it arrive on site with proper tools after preparing in advance.

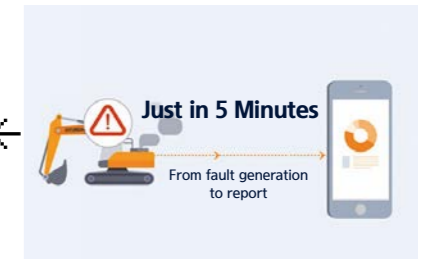

Urea Tank Cover **Upgrade**

Urea Tank Cover with full open type help operator fill urea into the tank directly and more conveniently.



Mobile Fleet App.

The new Mobile App is optimized to fleet management. It provides productivity, health insights based on telematics technology and enables fleet owner just focus on most wanted equipment in view of economical usage, utilization, fault codes and maintenance.

The new Mobile App sorts equipment in order of eco-index, utilization-index and fault code level automatically so that urgent equipment pops up automatically.

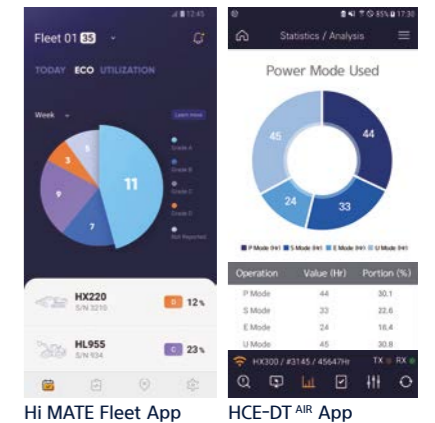

Connected Diagnostics

HCE-DT^{AIR} connect you and your equipment wirelessly via smartphone and laptop right on site. You can diagnose root causes and troubleshoot for fault codes through the connection. Engine connected diagnostics is a kind of cooperated remote diagnostics service between Cummins cloud and Hi-MATE cloud. It enables you get engine diagnostics report by cloud based fault code analysis in real-time and prepare parts, tools necessary in advance. It will help increase first visit fix rates.

SPECIFICATIONS

ENGINE

Maker / Model	CUMMINS / B4.5
Type	4 cylinder, watercooled, 4-cycle, turbocharged charge aircooled, direct injection, electronic controlled diesel engine
Gross Power	129 kW (173 hp) at 2,200 rpm
Net Power	127 kW (170 hp) at 2,200 rpm
Max. Power	142 kW (190 hp) at 2,000 rpm
Peak Torque	780 N·m (575 lb·ft) at 1,500 rpm
Displacement	4.5 l (275 cu in)

HYDRAULIC SYSTEM

MAIN PUMP

Type	Variable Displacement Tandem Axis Piston Pumps
Max. Flow	2 × 234 lpm
Sub-Pump For Pilot Circuit	Gear Pump

Cross-sensing and fuel saving pump system.

HYDRAULIC MOTORS

Travel	Two speed axial pistons motor with brake valve and parking brake
Swing	Axial piston motor with automatic brake

RELIEF VALVE SETTING

Implement Circuits	350 kgf/cm ² (4,980 psi)
Travel	350 kgf/cm ² (4,980 psi)
Power Boost (Boom, Arm, Bucket)	380 kgf/cm ² (5,400 psi)
Swing Circuit	265 kgf/cm ² (3,770 psi)
Pilot Circuit	40 kgf/cm ² (570psi)
Service Valve	Installed

HYDRAULIC CYLINDERS

No. of Cylinder Bore X Stroke	Boom: Ø120×1,290 mm
	Arm: Ø140×1,510 mm
	Bucket: Ø120×1,055 mm

* Hyundai Bio Hydraulic Oil (HBHO) available.

DRIVES & BRAKES

Drive Method	Fully Hydrostatic Type
Drive Motor	Axial Piston Motor, In-Shoe Design
Reduction System	Planetary Reduction Gear
Max. Drawbar Pull	20,800 kgf (45,860 lbf)
Max. Travel Speed (High / Low)	5.8 km/hr (3.6 mph) / 3.7 km/hr (2.3 mph)
Gradeability	35° (70%)
Parking Brake	Multi Wet Disc

CONTROL

Pilot pressure operated joysticks and pedals with detachable lever provide almost effortless and fatigueless operation.

Pilot Control	Two Joysticks with One Safety Lever (LH): Swing and Arm, Boom and Bucket
Traveling And Steering	Two Levers With Pedals
Engine Throttle	Electric, Dial Type

SWING SYSTEM

Swing Motor	Fixed Displacement Axial Piston Motor
Swing Reduction	Planetary Gear Reduction
Swing Bearing Lubrication	Grease-Bathed
Swing Brake	Multi Wet Disc
Swing Speed	12 rpm

CAPACITIES

	liter	US gal	UK gal
Fuel Tank	310	81.9	68.2
Engine Coolant	30	7.9	8.8
Engine Oil	11	2.9	5.1
Swing Device	6.2	1.6	1.36
Final Drive (Each)	4.5	1.2	1
Hydraulic System (Including Tank)	340	89.8	74.8
Hydraulic Tank	165	43.6	36.3
DEF/AdBlue®	47.5	12.5	10.4

UNDERCARRIAGE

The X-leg type center frame is integrally welded with reinforced box-section track frames. The undercarriage includes lubricated rollers, idlers, track adjusters with shock absorbing springs and sprockets, and a track chain with double or triple grouser shoes.

Center Frame	X - Leg Type
Track Frame	Pentagonal Box Type
No. of Shoes on Each Side	49 EA
No. of Carrier Roller on Each Side	2 EA
No. of Track Roller on Each Side	8 EA
No. of Rail Guard on Each Side	2 EA

OPERATING WEIGHT (APPROXIMATE)

Operating weight, including 5,650 mm (18' 6") boom, 2,920 mm (9' 7") arm, SAE heaped 0.92 m³ (1.20 yd³) bucket, lubricant, coolant, full fuel tank, full hydraulic tank, and all standard equipments.

Shoes	Type	Width mm (in)	Operating Weight		Ground Pressure
			kg (lb)	kgf/cm ² (psi)	
Triple Grouser	500 (20")	HX210A NL	22,800 (50,270)	0.58 (8.29)	
			22,150 (48,830)	0.47 (6.71)	
	600 (24")	HX210A NL	22,900 (50,490)	0.49 (6.93)	
			22,620 (49,870)	0.41 (5.87)	
	800 (32")	HX210A L	22,890 (50,460)	0.37 (5.20)	
			23,170 (51,080)	0.33 (4.68)	
900 (36")	HX210A L	22,880 (50,440)	0.42 (5.94)		

AIR CONDITIONING SYSTEM

The air condition system for the machine contains the fluorinated greenhouse gas with global warming potential of R134a. (Global Warming Potential : 1,430)
The system hold 0.80kg refrigerant consisting of a CO₂ of 1.14 metric tonnes. For more information, Please refer to the manual.

DIMENSIONS & WORKING RANGE

HX210A L / HX210A NL DIMENSIONS

5.65 m (18' 6") BOOM and 2.0 m (6' 7"), 2.4 m (7' 10"), 2.92 m (9' 7"), 3.9 m (12' 10") ARM

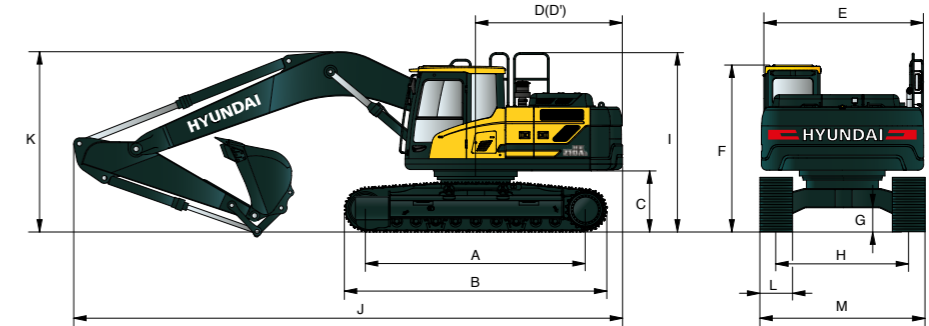

Unit : mm (ft - in)

A Tumbler Distance	3,650 (12' 0")
B Overall Length of Crawler	4,395 (14' 5")
*C Ground Clearance of Counter weight	1,095 (3' 7")
D Tail Swing Radius	2,850 (9' 4")
D' Rear-End Length	2,770 (9' 1")
E Overall Width of Upperstructure	2,530 (8' 3")
*F Overall Height of Cab	3,035 (9' 11")
*G Min. Ground Clearance	475 (1' 7")
H Track Gauge	HX210A L 2,390 (7' 10")
	HX210A NL 2,040 (6' 8")
*I Overall Height of Guardrail	3,245 (10' 8")

* This figure includes the size of grousers.

Boom Length	5,650 (18' 6")			
Arm Length	2,000 (6' 7")	2,400 (7' 10")	2,920 (9' 7")	3,900 (12' 10")
J Overall Length	9,650 (31' 8")	9,570 (31' 5")	9,510 (31' 2")	9,480 (31' 1")
*K Overall Height of Boom	3,250 (10' 8")	3,170 (10' 5")	3,100 (10' 2")	3,500 (11' 6")

HX210A L		TRIPLE GROUSER				DOUBLE GROUSER
L Track Shoe Width	600 (24")	700 (28")	800 (32")	900 (35")	700 (28")	
		2,990 (9' 10")	3,090 (10' 2")	3,190 (10' 6")		3,290 (10' 10")
M Overall Width		3,090 (10' 2")	3,190 (10' 6")	3,290 (10' 10")	3,090 (10' 2")	

HX210A NL		TRIPLE GROUSER		
L Track Shoe Width	500 (20")	600 (24")		
		2,540 (8' 4")	2,640 (8' 8")	
M Overall Width		2,540 (8' 4")	2,640 (8' 8")	

HX210A L / HX210A NL WORKING RANGE

Unit : mm (ft - in)

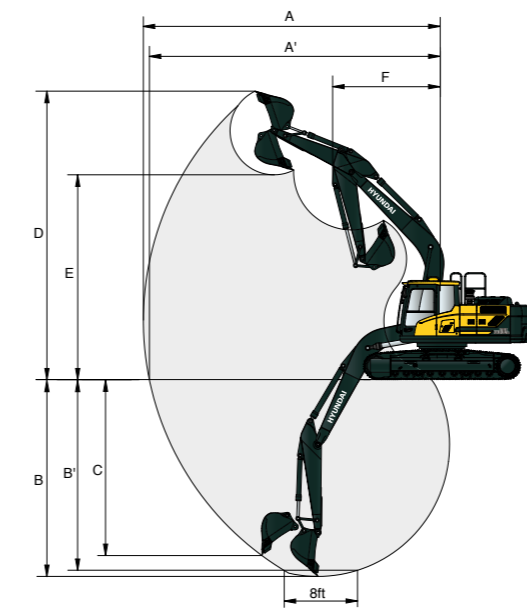

Boom Length	5,650 (18' 6")			
Arm Length	2,000 (6' 7")	2,400 (7' 10")	2,920 (9' 7")	3,900 (12' 10")
A Max. Digging Reach	9,140 (30' 0")	9,500 (31' 2")	9,960 (32' 8")	10,900 (35' 9")
A' Max. Digging Reach on Ground	8,960 (29' 5")	9,340 (30' 8")	9,800 (32' 2")	10,750 (35' 3")
B Max. Digging Depth	5,750 (18' 10")	6,150 (20' 2")	6,640 (21' 9")	7,610 (25' 0")
B' Max. Digging Depth (8' Level)	5,520 (18' 1")	5,950 (19' 6")	6,470 (21' 3")	7,460 (24' 6")
C Max. Vertical Wall Digging Depth	5,320 (17' 5")	5,780 (19' 0")	6,250 (20' 6")	6,940 (22' 9")
D Max. Digging Height	9,270 (30' 5")	9,500 (31' 2")	9,740 (31' 11")	10,310 (33' 10")
E Max. Dumping Height	6,450 (21' 2")	6,660 (21' 10")	6,900 (22' 8")	7,470 (24' 6")
F Min. Swing Radius	3,710 (12' 2")	3,630 (11' 11")	3,580 (11' 9")	6,850 (22' 6")

DIMENSIONS & WORKING RANGE

HX210A L / HX210A NL 2-PIECE BOOM DIMENSIONS

5.65 m (18' 6") 2-Piece BOOM and 2.0 m (6' 7"), 2.4 m (7' 10"), 2.92 m (9' 7") ARM

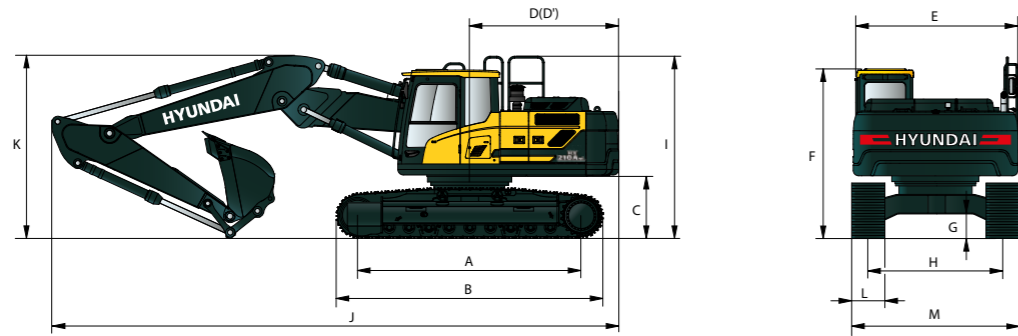

Unit : mm (ft.-in)

A	Tumbler Distance	3,650 (12' 0")
B	Overall Length of Crawler	4,395 (14' 5")
*C	Ground Clearance of Counter weight	1,095 (3' 7")
D	Tail Swing Radius	2,850 (9' 4")
D'	Rear-End Length	2,770 (9' 1")
E	Overall Width of Upperstructure	2,530 (8' 3")
*F	Overall Height of Cab	3,035 (9' 11")
*G	Min. Ground Clearance	475 (1' 7")
H	Track Gauge	HX210A L 2,390 (7' 10")
		HX210A NL 2,040 (6' 8")
*I	Overall Height of Guardrail	3,245 (10' 8")

* This figure includes the size of grouser.

Boom Length	5,650 2-Piece (18' 6")		
Arm Length	2,000 (6' 7")	2,400 (7' 10")	2,920 (9' 7")
J Overall Length	9,650 (31' 8")	9,550 (31' 4")	9,520 (31' 3")
*K Overall Height of Boom	3,200 (10' 6")	3,000 (9' 10")	3,030 (9' 11")

HX210A L		TRIPLE GROUSER				DOUBLE GROUSER
L	Track Shoe Width	600 (24")	700 (28")	800 (32")	900 (35")	700 (28")
M	Overall Width	2,990 (9' 10")	3,090 (10' 2")	3,190 (10' 6")	3,290 (10' 10")	3,090 (10' 2")

HX210A NL		TRIPLE GROUSER	
L	Track Shoe Width	500 (20")	600 (24")
M	Overall Width	2,540 (8' 4")	2,640 (8' 8")

HX210A L / HX210A NL 2-PIECE BOOM WORKING RANGE

Unit : mm (ft.-in)

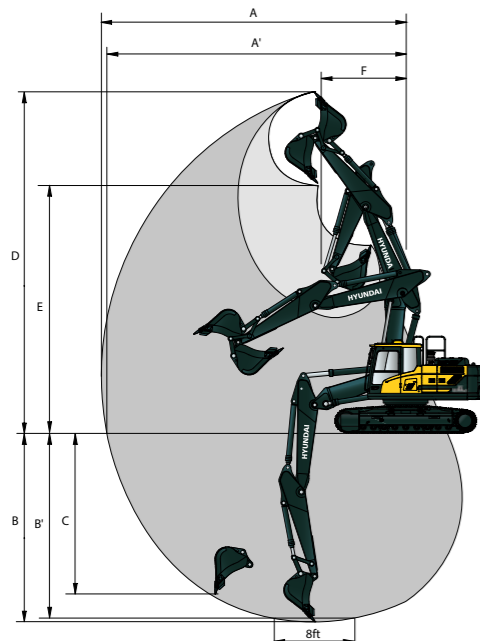

Boom Length	5,650 2-Piece (18' 6")			
Arm Length	2,000 (6' 7")	2,400 (7' 10")	2,920 (9' 7")	
A	Max. Digging Reach	9,120 (29' 11")	9,530 (31' 3")	10,020 (32' 10")
A'	Max. Digging Reach on Ground	8,940 (29' 4")	9,360 (30' 9")	9,860 (32' 4")
B	Max. Digging Depth	5,480 (18' 0")	5,890 (19' 4")	6,400 (21' 0")
B'	Max. Digging Depth (8' Level)	5,360 (17' 7")	5,770 (18' 11")	6,300 (20' 8")
C	Max. Vertical Wall Digging Depth	4,560 (15' 0")	4,990 (16' 4")	5,530 (18' 2")
D	Max. Digging Height	10,300 (33' 10")	10,670 (35' 0")	11,080 (36' 4")
E	Max. Dumping Height	7,390 (24' 3")	7,740 (25' 5")	8,160 (26' 9")
F	Min. Swing Radius	2,870 (9' 5")	2,670 (8' 9")	2,540 (8' 4")

LIFTING CAPACITY

Rating over-front Rating over-side or 360 degree

HX210A L MONO BOOM

Boom 5.65 m (18' 6") / Arm 2.0 m (6' 7") / CWT 3,800kg (8,380lb) / Shoe 800mm (32") triple grouser

Lift-point height m (ft)	Lift-point radius								At max. reach		
	3.0 m (9.8 ft)		4.5 m (14.8 ft)		6.0 m (19.7 ft)		7.5 m (24.6 ft)		Capacity	Reach	
7.5m 24.6ft	kg lb								*5,720 *12,610	*5,720 *12,610	4.96 (16.3)
6.0m 19.7ft	kg lb			*5,470 *12,060	5,230 11,530				*5,550 *12,240	4,790 10,560	6.32 (20.7)
4.5m 14.8ft	kg lb		*6,860 *15,120	*6,860 *15,120	*5,810 *12,810	5,110 11,270			*5,600 *12,350	3,920 8,640	7.11 (23.3)
3.0m 9.8ft	kg lb		*8,680 *19,140	7,370 16,250	*6,550 *14,440	4,900 10,800	5,470 12,060	3,530 7,780	5,450 12,020	3,520 7,760	7.52 (24.7)
1.5m 4.9ft	kg lb				*7,290 *16,070	4,710 10,380	5,390 11,880	3,460 7,630	5,280 11,640	3,390 7,470	7.61 (25.0)
0.0m 0.0ft	kg lb		*10,590 *23,350	6,850 15,100	7,370 16,250	4,590 10,120			5,450 12,020	3,480 7,670	7.40 (24.3)
-1.5m -4.9ft	kg lb		*10,320 *22,750	6,870 15,150	7,360 16,230	4,580 10,100			6,100 13,450	3,870 8,530	6.85 (22.5)
-3.0m -9.8ft	kg lb	*12,600 *27,780	*12,600 *27,780	*9,240 *20,370	7,000 15,430				*6,790 *14,970	4,860 10,710	5.87 (19.3)
-4.5m -14.8ft	kg lb										

Boom 5.65 m (18' 6") / Arm 2.4 m (7' 10") / CWT 3,800kg (8,380lb) / Shoe 800mm (32") triple grouser

Lift-point height m (ft)	Lift-point radius								At max. reach		
	3.0 m (9.8 ft)		4.5 m (14.8 ft)		6.0 m (19.7 ft)		7.5 m (24.6 ft)		Capacity	Reach	
7.5m 24.6ft	kg lb								*4,900 *10,800	*4,900 *10,800	5.55 (18.2)
6.0m 19.7ft	kg lb			*5,010 *11,050	*5,010 *11,050				*4,430 *9,770	4,290 9,460	6.79 (22.3)
4.5m 14.8ft	kg lb		*6,310 *13,910	*6,310 *13,910	*5,450 *12,020	5,140 11,330	*4,610 *10,160	3,600 7,940	*4,300 *9,480	3,580 7,890	7.53 (24.7)
3.0m 9.8ft	kg lb		*8,130 *17,920	7,460 16,450	*6,240 *13,760	4,920 10,850	*5,450 *12,020	3,530 7,780	*4,380 *9,660	3,240 7,140	7.92 (26.0)
1.5m 4.9ft	kg lb		*9,720 *21,430	7,020 15,480	*7,050 *15,540	4,700 10,360	5,370 11,840	3,440 7,580	*4,650 *10,250	3,130 6,900	8.01 (26.3)
0.0m 0.0ft	kg lb		*10,470 *23,080	6,820 15,040	7,340 16,180	4,570 10,080	5,310 11,710	3,370 7,430	5,020 11,070	3,200 7,050	7.80 (25.6)
-1.5m -4.9ft	kg lb	*11,180 *24,650	*11,180 *24,650	*10,420 *22,970	6,800 14,990	7,300 16,090	4,530 9,990		5,530 12,190	3,510 7,740	7.29 (23.9)
-3.0m -9.8ft	kg lb	*13,470 *29,700	13,460 29,670	*9,600 *21,160	6,900 15,210	*7,030 *15,500	4,610 10,160		*6,400 *14,110	4,270 9,410	6.38 (20.9)
-4.5m -14.8ft	kg lb			*7,230 *15,940	7,200 15,870				*6,450 *14,220	*6,450 *14,220	4.85 (15.9)

1 | Lifting capacity are based on ISO 10567.

2 | Lifting capacity of HX A Series does not exceed 75% of tipping load with the machine on firm, level ground or 87% of full hydraulic capacity.

3 | The Lift-point is bucket pivot mounting pin on the arm(without bucket mass).













4 | (*) indicates load limited by hydraulic capacity.

LIFTING CAPACITY















 Rating over-front  Rating over-side or 360 degree

HX210A L MONO BOOM

Boom 5.65 m (18' 6") / Arm 2.92 m (9' 7") / CWT 3,800kg (8,380lb) / Shoe 800mm (32") triple grouser

Lift-point height m (ft)	Lift-point radius										At max. reach			
	1.5 m (4.9 ft)		3.0 m (9.8 ft)		4.5 m (14.8 ft)		6.0 m (19.7 ft)		7.5 m (24.6 ft)		Capacity		Reach	
													m (ft)	
7.5m 24.6ft	kg lb											*3,190 *3,190	*3,190 *3,190	6.24 (20.5)
6.0m 19.7ft	kg lb											*2,920 *2,920	*2,920 *2,920	7.36 (24.1)
4.5m 14.8ft	kg lb											*2,840 *2,840	*2,840 *2,840	8.05 (26.4)
3.0m 9.8ft	kg lb											*2,880 *2,880	*2,880 *2,880	8.41 (27.6)
1.5m 4.9ft	kg lb											*3,040 *3,040	*2,830 *2,830	8.49 (27.9)
0.0m 0.0ft	kg lb											*3,360 *3,360	*2,880 *2,880	8.30 (27.2)
-1.5m -4.9ft	kg lb	*6,700 *14,770	*6,700 *14,770	*10,680 *23,550	*10,680 *23,550	*10,430 *22,990	*6,710 14,790	7,230 15,940	4,450 9,810	5,230 11,530	3,290 7,250	*3,920 *8,640	*3,120 6,880	7.82 (25.7)
-3.0m -9.8ft	kg lb	*11,310 *24,930	*11,310 *24,930	*14,370 *31,680	13,210 29,120	*9,920 *21,870	6,770 14,930	7,260 16,010	4,490 9,900			*5,050 *11,130	3,690 8,140	6.98 (22.9)
-4.5m -14.8ft	kg lb			*11,800 *26,010	*11,800 *26,010	*8,290 *18,280	6,980 15,390					*6,180 *13,620	5,110 11,270	5.63 (18.5)

Boom 5.65 m (18' 6") / Arm 3.9 m (12' 10") / CWT 3,800kg (8,380lb) / Shoe 800mm (32") triple grouser

Lift-point height m (ft)	Lift-point radius										At max. reach					
	1.5 m (4.9 ft)		3.0 m (9.8 ft)		4.5 m (14.8 ft)		6.0 m (19.7 ft)		7.5 m (24.6 ft)		9.0 m (29.5 ft)		Capacity		Reach	
															m (ft)	
7.5m 24.6ft	kg lb													*2,200 *4,850	*2,200 *4,850	7.47 (24.5)
6.0m 19.7ft	kg lb													*2,040 *4,500	*2,040 *4,500	8.42 (27.6)
4.5m 14.8ft	kg lb													*1,990 *4,390	*1,990 *4,390	9.03 (29.6)
3.0m 9.8ft	kg lb													*2,010 *4,430	*2,010 *4,430	9.36 (30.7)
1.5m 4.9ft	kg lb													*2,100 *4,630	*2,100 *4,630	9.43 (30.9)
0.0m 0.0ft	kg lb													*2,290 *5,050	*2,290 *5,050	9.26 (30.4)
-1.5m -4.9ft	kg lb	*5,580 *12,300	*5,580 *12,300	*9,610 *21,190	*9,610 *21,190	*10,100 *22,270	6,530 14,400	7,100 15,650	4,320 9,520	5,090 11,220	3,150 6,940	*2,600 *5,730	2,520 5,560	8.83 (29.0)		
-3.0m -9.8ft	kg lb	*8,660 *19,090	*8,660 *19,090	*13,300 *29,320	12,690 27,980	*10,130 *22,330	6,500 14,330	7,050 15,540	4,280 9,440	5,080 11,200	3,150 6,940	*3,160 *6,970	2,860 6,310	8.10 (26.6)		
-4.5m -14.8ft	kg lb	*12,540 *27,650	*12,540 *27,650	*13,730 *30,270	12,970 28,590	*9,330 *20,570	6,620 14,590	*6,800 *14,990	4,370 9,630			*4,350 *9,590	3,590 7,910	6.97 (22.9)		
-6.0m -19.7ft	kg lb													*6,950 *15,320	6,950 15,320	

1 | 1 | Lifting capacity are based on ISO 10567.

1 | 2 | Lifting capacity of HX A Series does not exceed 75% of tipping load with the machine on firm, level ground or 87% of full hydraulic capacity.

1 | 3 | The Lift-point is bucket pivot mounting pin on the arm(without bucket mass).













1 | 4 | (*) indicates load limited by hydraulic capacity.

LIFTING CAPACITY













 Rating over-front  Rating over-side or 360 degree

HX210A NL MONO BOOM

Boom 5.65 m (18' 6") / Arm 2.40 m (7' 9") / CWT 4,700kg (10,360lb) / Shoe 500mm (20") triple grouser

Lift-point height m (ft)	Lift-point radius										At max. reach					
	3.0 m (9.8 ft)		4.5 m (14.8 ft)		6.0 m (19.7 ft)		7.5 m (24.6 ft)		Capacity		Reach					
													m (ft)			
7.5m 24.6ft	kg lb												*4,900 *10,800	*4,900 *10,800	5.55 (18.2)	
6.0m 19.7ft	kg lb												*5,010 *11,050	4,750 10,470	6.79 (22.3)	
4.5m 14.8ft	kg lb												*6,310 *13,910	*6,310 *13,910	7.53 (24.7)	
3.0m 9.8ft	kg lb												*8,130 *17,920	6,570 14,480	7.92 (26.0)	
1.5m 4.9ft	kg lb												*9,720 *21,430	6,160 13,580	8.01 (26.3)	
0.0m 0.0ft	kg lb												*10,470 *23,080	5,970 13,160	7.80 (25.6)	
-1.5m -4.9ft	kg lb	*11,180 *24,650	11,090 24,450	*10,420 *22,970	5,950 13,120	7,670 16,910	4,030 8,880							5,820 12,830	3,150 6,940	7.29 (23.9)
-3.0m -9.8ft	kg lb	*13,470 *29,700	11,270 24,850	*9,600 *21,160	6,050 13,340	*7,030 *15,500	4,110 9,060							*6,400 *14,110	3,820 8,420	6.38 (20.9)
-4.5m -14.8ft	kg lb													*7,230 *15,940	6,330 13,960	4.85 (15.9)

Boom 5.65 m (18' 6") / Arm 2.92 m (9' 7") / CWT 4,700kg (10,360lb) / Shoe 500mm (20") triple grouser

Lift-point height m (ft)	Lift-point radius										At max. reach					
	1.5 m (4.9 ft)		3.0 m (9.8 ft)		4.5 m (14.8 ft)		6.0 m (19.7 ft)		7.5 m (24.6 ft)		Capacity		Reach			
													m (ft)			
7.5m 24.6ft	kg lb													*4,250 *9,370	*4,250 *9,370	6.24 (20.5)
6.0m 19.7ft	kg lb													*4,440 *9,790	*4,440 *9,790	7.36 (24.1)
4.5m 14.8ft	kg lb													*4,950 *10,910	4,660 10,270	8.05 (26.4)
3.0m 9.8ft	kg lb													*7,370 *16,250	6,680 14,730	8.41 (27.6)
1.5m 4.9ft	kg lb													*9,140 *20,150	6,200 13,670	8.49 (27.9)
0.0m 0.0ft	kg lb													*6,220 *13,710	*6,220 *13,710	9.26 (30.4)
-1.5m -4.9ft	kg lb	*6,700 *14,770	*6,700 *14,770	*10,680 *23,550	*10,680 *23,550	*10,430 *22,990	6,530 14,400	7,100 15,650	4,320 9,520	5,090 11,220	3,150 6,940	*2,600 *5,730	2,520 5,560	8.83 (29.0)		
-3.0m -9.8ft	kg lb	*11,310 *24,930	*11,310 *24,930	*14,370 *31,680	11,030 24,320	*9,920 *21,870	6,500 14,330	7,050 15,540	4,280 9,440	5,080 11,200	3,150 6,940	*3,160 *6,970	2,860 6,310	8.10 (26.6)		
-4.5m -14.8ft	kg lb													*11,800 *26,010	11,380 25,090	5.63 (18.5)

1 | 1 | Lifting capacity are based on ISO 10567.

1 | 2 | Lifting capacity of HX A Series does not exceed 75% of tipping load with the machine on firm, level ground or 87% of full hydraulic capacity.

1 | 3 | The Lift-point is bucket pivot mounting pin on the arm(without bucket mass).











1 | 4 | (*) indicates load limited by hydraulic capacity.

LIFTING CAPACITY











 Rating over-front  Rating over-side or 360 degree

HX210A L 2-PIECE BOOM

Boom 5.65 m (18' 6") / Arm 2.40 m (7' 9") / CWT 3,800kg (8,380lb) / Shoe 800mm (32") triple grouser

Lift-point height m (ft)		Lift-point radius								At max. reach		
		3.0 m (9.8 ft)		4.5 m (14.8 ft)		6.0 m (19.7 ft)		7.5 m (24.6 ft)		Capacity		Reach
												m (ft)
9.0m	kg									*6,600	*6,600	3.38
29.5ft	lb									*14,550	*14,550	(11.1)
7.5m	kg			*6,520	*6,520					*4,880	*4,880	5.62
24.6ft	lb			*14,370	*14,370					*10,760	*10,760	(18.4)
6.0m	kg			*6,640	*6,640	*5,300	5,290			*4,360	4,200	6.85
19.7ft	lb			*14,640	*14,640	*11,680	11,660			*9,610	9,260	(22.5)
4.5m	kg			*7,560	*7,560	*5,560	5,130	*4,500	3,560	*4,200	3,490	7.58
14.8ft	lb			*16,670	*16,670	*12,260	11,310	*9,920	7,850	*9,260	7,690	(24.9)
3.0m	kg			*9,640	7,420	*6,130	4,880	*4,620	3,480	*4,230	3,150	7.97
9.8ft	lb			*21,250	16,360	*13,510	10,760	*10,190	7,670	*9,330	6,940	(26.1)
1.5m	kg			*10,330	6,910	*6,880	4,630	*4,850	3,370	*4,420	3,040	8.05
4.9ft	lb			*22,770	15,230	*15,170	10,210	*10,690	7,430	*9,740	6,700	(26.4)
0.0m	kg			*10,010	6,690	7,330	4,480	*5,060	3,300	*4,710	3,110	7.85
0.0ft	lb			*22,070	14,750	16,160	9,880	*11,160	7,280	*10,380	6,860	(25.8)
-1.5m	kg	*10,590	*10,590	*8,830	6,670	*6,710	4,440			*4,810	3,420	7.34
-4.9ft	lb	*23,350	*23,350	*19,470	14,700	*14,790	9,790			*10,600	7,540	(24.1)
-3.0m	kg			*6,690	*6,690	*4,850	4,540					
-9.8ft	lb			*14,750	*14,750	*10,690	10,010					

Boom 5.65 m (18' 6") / Arm 2.92 m (9' 7") / CWT 3,800kg (8,380lb) / Shoe 800mm (32") triple grouser

Lift-point height m (ft)		Lift-point radius								At max. reach		
		3.0 m (9.8 ft)		4.5 m (14.8 ft)		6.0 m (19.7 ft)		7.5 m (24.6 ft)		Capacity		Reach
												m (ft)
9.0m	kg									*3,940	*3,940	4.46
29.5ft	lb									*8,690	*8,690	(14.6)
7.5m	kg			*6,020	*6,020	*4,590	*4,590			*3,130	*3,130	6.32
24.6ft	lb			*13,270	*13,270	*10,120	*10,120			*6,900	*6,900	(20.7)
6.0m	kg			*6,170	*6,170	*4,950	*4,950			*2,830	*2,830	7.43
19.7ft	lb			*13,600	*13,600	*10,910	*10,910			*6,240	*6,240	(24.4)
4.5m	kg	*9,140	*9,140	*6,930	*6,930	*5,220	5,190	*4,200	3,600	*2,730	*2,730	8.11
14.8ft	lb	*20,150	*20,150	*15,280	*15,280	*11,510	11,440	*9,260	7,940	*6,020	*6,020	(26.6)
3.0m	kg			*8,690	7,570	*5,770	4,920	*4,380	3,490	*2,750	*2,750	8.47
9.8ft	lb			*19,160	16,690	*12,720	10,850	*9,660	7,690	*6,060	*6,060	(27.8)
1.5m	kg			*10,100	6,980	*6,520	4,640	*4,640	3,350	*2,870	2,740	8.55
4.9ft	lb			*22,270	15,390	*14,370	10,230	*10,230	7,390	*6,330	6,040	(28.1)
0.0m	kg			*10,160	6,660	*7,260	4,440	*4,890	3,250	*3,130	2,800	8.36
0.0ft	lb			*22,400	14,680	*16,010	9,790	*10,780	7,170	*6,900	6,170	(27.4)
-1.5m	kg	*10,190	*10,190	*9,300	6,570	*6,970	4,360	*5,040	3,230	*3,600	3,030	7.88
-4.9ft	lb	*22,470	*22,470	*20,500	14,480	*15,370	9,610	*11,110	7,120	*7,940	6,680	(25.9)
-3.0m	kg	*9,470	*9,470	*7,530	6,650	*5,620	4,410			*3,990	3,590	7.05
-9.8ft	lb	*20,880	*20,880	*16,600	14,660	*12,390	9,720			*8,800	7,910	(23.1)











1 | 1 | Lifting capacity are based on ISO 10567.
 2 | 2 | Lifting capacity of HX A Series does not exceed 75% of tipping load with the machine on firm, level ground or 87% of full hydraulic capacity.
 3 | 3 | The Lift-point is bucket pivot mounting pin on the arm(without bucket mass).
 4 | 4 | (*) indicates load limited by hydraulic capacity.

LIFTING CAPACITY











 Rating over-front  Rating over-side or 360 degree

HX210A NL 2-PIECE BOOM

Boom 5.65 m (18' 6") / Arm 2.40 m (7' 9") / CWT 4,700kg (10,360lb) / Shoe 500mm (20") triple grouser

Lift-point height m (ft)		Lift-point radius								At max. reach		
		3.0 m (9.8 ft)		4.5 m (14.8 ft)		6.0 m (19.7 ft)		7.5 m (24.6 ft)		Capacity		Reach
												m (ft)
9.0m	kg									*6,600	*6,600	3.38
29.5ft	lb									*14,550	*14,550	(11.1)
7.5m	kg			*6,520	*6,520					*4,880	*4,880	5.62
24.6ft	lb			*14,370	*14,370					*10,760	*10,760	(18.4)
6.0m	kg			*6,640	*6,640	*5,300	4,720			*4,360	3,750	6.85
19.7ft	lb			*14,640	*14,640	*11,680	10,410			*9,610	8,270	(22.5)
4.5m	kg			*7,560	7,070	*5,560	4,570	*4,500	3,180	*4,200	3,110	7.58
14.8ft	lb			*16,670	15,590	*12,260	10,080	*9,920	7,010	*9,260	6,860	(24.9)
3.0m	kg			*9,640	6,480	*6,130	4,320	*4,620	3,100	*4,230	2,810	7.97
9.8ft	lb			*21,250	14,290	*13,510	9,520	*10,190	6,830	*9,330	6,190	(26.1)
1.5m	kg			*10,330	6,000	*6,880	4,090	*4,850	3,000	*4,420	2,700	8.05
4.9ft	lb			*22,770	13,230	*15,170	9,020	*10,690	6,610	*9,740	5,950	(26.4)
0.0m	kg			*10,010	5,790	*7,460	3,940	*5,060	2,930	*4,710	2,760	7.85
0.0ft	lb			*22,070	12,760	*16,450	8,690	*11,160	6,460	*10,380	6,080	(25.8)
-1.5m	kg	*10,590	*10,590	*8,830	5,770	*6,710	3,900			*4,810	3,030	7.34
-4.9ft	lb	*23,350	*23,350	*19,470	12,720	*14,790	8,600			*10,600	6,680	(24.1)
-3.0m	kg			*6,690	5,900	*4,850	4,000					
-9.8ft	lb			*14,750	13,010	*10,690	8,820					

Boom 5.65 m (18' 6") / Arm 2.92 m (9' 7") / CWT 4,700kg (10,360lb) / Shoe 500mm (20") triple grouser

Lift-point height m (ft)		Lift-point radius								At max. reach		
		3.0 m (9.8 ft)		4.5 m (14.8 ft)		6.0 m (19.7 ft)		7.5 m (24.6 ft)		Capacity		Reach
												m (ft)
9.0m	kg									*3,940	*3,940	4.46
29.5ft	lb									*8,690	*8,690	(14.6)
7.5m	kg			*6,020	*6,020	*4,590	*4,590			*3,130	*3,130	6.32
24.6ft	lb			*13,270	*13,270	*10,120	*10,120			*6,900	*6,900	(20.7)
6.0m	kg			*6,170	*6,170	*4,950	4,800			*2,830	*2,830	7.43
19.7ft	lb			*13,600	*13,600	*10,910	10,580			*6,240	*6,240	(24.4)
4.5m	kg	*9,140	*9,140	*6,930	*6,930	*5,220	4,630	*4,200	3,210	*2,730	*2,730	8.11
14.8ft	lb	*20,150	*20,150	*15,280	*15,280	*11,510	10,210	*9,260	7,080	*6,020	*6,020	(26.6)
3.0m	kg			*8,690	6,610	*5,770	4,360	*4,380	3,100	*2,750	2,530	8.47
9.8ft	lb			*19,160	14,570	*12,720	9,610	*9,660	6,830	*6,060	5,580	(27.8)
1.5m	kg			*10,100	6,060	*6,520	4,090	*4,640	2,970	*2,870	2,430	8.55
4.9ft	lb			*22,270	13,360	*14,370	9,020	*10,230	6,550	*6,330	5,360	(28.1)
0.0m	kg			*10,160	5,760	*7,260	3,900	*4,890	2,880	*3,130	2,480	8.36
0.0ft	lb			*22,400	12,700	*16,010	8,600	*10,780	6,350	*6,900	5,470	(27.4)
-1.5m	kg	*10,190	*10,190	*9,300	5,680	*6,970	3,830	*5,040	2,850	*3,600	2,680	7.88
-4.9ft	lb	*22,470	*22,470	*20,500	12,520	*15,370	8,440	*11,110	6,280	*7,940	5,910	(25.9)
-3.0m	kg	*9,470	*9,470	*7,530	5,750	*5,620	3,870			*3,990	3,170	7.05
-9.8ft	lb	*20,880	*20,880	*16,600	12,680	*12,390	8,530			*8,800	6,990	(23.1)

1 | 1 | Lifting capacity are based on ISO 10567.
 2 | 2 | Lifting capacity of HX A Series does not exceed 75% of tipping load with the machine on firm, level ground or 87

BUCKET SELECTION GUIDE & DIGGING FORCE

BUCKETS

All buckets are welded with high-strength steel.

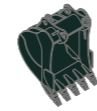
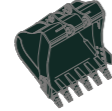
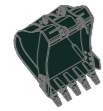

- SAE heaped
m³ (yd³)
- 0.80 (1.05)
 - 0.87 (1.14)
 - 0.92 (1.20)
 - 1.10 (1.44)
 - 1.20 (1.57)

○ 1.34 (1.75)

- ◇ 0.90 (1.18)
- ◇ 1.05 (1.37)
- ◇ 0.85 (1.11)
- ◇ 1.00 (1.31)
- ◇ 1.15 (1.50)

◆ 0.87 (1.14)

Type	Capacity m ³ (yd ³)		Width mm (in)	Weight kg (lb)	Tooth (EA)	Recommendation mm (ft.in)									
	SAE Heaped	CECE Heaped				5,650 (18' 6") Mono Boom				5,650(18' 6") 2-Piece					
	Without Side Cutters	2,000 (6' 7") Arm	2,400 (7' 10") Arm	2,920 (9' 7") Arm	3,900 (12' 10") Arm	2,000 (6' 7") Arm	2,400 (7' 10") Arm	2,920 (9' 7") Arm							
HX210A L	○ 0.80 (1.05)	0.70 (0.92)	1,070 (42")	770 (1,700)	5	●	●	●	○	●	●	●			
	○ 0.87 (1.14)	0.76 (0.99)	1,140 (45")	804 (1,770)	5	●	●	●	○	●	●	●			
	○ 0.92 (1.20)	0.80 (1.05)	1,190 (47")	820 (1,810)	5	●	●	●	■	●	●	○			
	○ 1.10 (1.44)	0.96 (1.26)	1,375 (54")	890 (1,960)	5	●	○	■	▲	●	○	■			
	○ 1.20 (1.57)	1.05 (1.37)	1,390 (55")	920 (2,030)	5	○	○	■	▲	○	■	■			
	○ 1.34 (1.75)	1.17 (1.53)	1,525 (60")	990 (2,180)	6	○	■	▲	×	■	■	▲			
	◇ 0.90 (1.18)	0.79 (1.03)	1,210 (48")	880 (1,940)	5	●	●	●	■	●	●	○			
	◇ 1.05 (1.37)	0.92 (1.20)	1,355 (53")	940 (2,070)	5	●	●	○	▲	●	○	■			
	◇ 0.85 (1.11)	0.76 (0.99)	962 (38")	860 (1,900)	4	●	●	●	○	●	●	●			
	◇ 1.00 (1.31)	0.89 (1.16)	1,112 (44")	950 (2,090)	5	●	●	○	▲	●	●	○			
◇ 1.15 (1.50)	1.01 (1.32)	1,262 (50")	1,030 (2,270)	6	●	○	■	▲	○	○	■				
◆ 0.87 (1.14)	0.77 (1.01)	1,195 (47")	940 (2,070)	5	●	●	●	-	●	●	●				
HX210A NL	○ 0.80 (1.05)	0.70 (0.92)	1,070 (42")	770 (1,700)	5	●	●	○	▲	●	●	●			
	○ 0.87 (1.14)	0.76 (0.99)	1,140 (45")	804 (1,770)	5	●	○	■	▲	●	●	○			
	○ 0.92 (1.20)	0.80 (1.05)	1,190 (47")	820 (1,810)	5	●	○	■	×	●	○	■			
	○ 1.10 (1.44)	0.96 (1.26)	1,375 (54")	890 (1,960)	5	■	■	▲	×	○	■	▲			
	○ 1.20 (1.57)	1.05 (1.37)	1,390 (55")	920 (2,030)	5	■	▲	×	×	■	■	▲			
	○ 1.34 (1.75)	1.17 (1.53)	1,525 (60")	990 (2,180)	6	▲	▲	×	×	■	▲	×			
	◇ 0.90 (1.18)	0.79 (1.03)	1,210 (48")	880 (1,940)	5	●	○	■	×	●	○	■			
	◇ 1.05 (1.37)	0.92 (1.20)	1,355 (53")	940 (2,070)	5	■	■	▲	×	○	■	▲			
	◇ 0.85 (1.11)	0.76 (0.99)	962 (38")	860 (1,900)	4	●	○	■	▲	●	●	○			
	◇ 1.00 (1.31)	0.89 (1.16)	1,112 (44")	950 (2,090)	5	○	■	▲	×	○	○	■			
◇ 1.15 (1.50)	1.01 (1.32)	1,262 (50")	1,030 (2,270)	6	■	▲	×	×	■	■	▲				
◆ 0.87 (1.14)	0.77 (1.01)	1,195 (47")	940 (2,070)	5	●	○	■	×	●	●	○				

- General Purpose
- ◇ Heavy Duty
- ◆ Rock-HD
- : Applicable for materials with density of 2,100 kg/m³ (3,500 lb/yd³) or less
- : Applicable for materials with density of 1,800 kg/m³ (3,000 lb/yd³) or less
- : Applicable for materials with density of 1,500 kg/m³ (2,500 lb/yd³) or less
- ▲: Applicable for materials with density of 1,200 kg/m³ (2,000 lb/yd³) or less
- ×: Not Recommended

ATTACHMENT

Booms and arms are welded with a low-stress, full-box section design.
5.65 Mono & 5.65 2-Piece Booms and 2.0 m, 2.4 m, 2.92 m, 3.9 m Arms are available.

BUCKET SELECTION GUIDE & DIGGING FORCE

DIGGING FORCE

Boom	Length	mm (ft.in)	5,650 (18' 6")				Remark
	Weight	kg (lb)	1,950 (4,300) & 2,600 (5,730)				
Arm	Length	mm (ft.in)	2,000 (6' 7")	2,400 (7' 10")	2,920 (9' 7")	3,900 (12' 10")	
	Weight	kg (lb)	975 (2,150)	1,045 (2,300)	1,095 (2,410)	1,295 (2,850)	
Bucket Digging Force	SAE	kN	133.4 [144.8]	133.4 [144.8]	133.4 [144.8]	133.4 [144.8]	
		kgf	13,600 [14,770]	13,600 [14,770]	13,600 [14,770]	13,600 [14,770]	
		lbf	29,980 [32,560]	29,980 [32,560]	29,980 [32,560]	29,980 [32,560]	
	ISO	kN	152.0 [165.0]	152.0 [165.0]	152.0 [165.0]	152.0 [165.0]	
		kgf	15,500 [16,830]	15,500 [16,830]	15,500 [16,830]	15,500 [16,830]	
		lbf	34,170 [37,100]	34,170 [37,100]	34,170 [37,100]	34,170 [37,100]	
Arm Crowd Force	SAE	kN	144.2 [156.5]	119.6 [129.9]	102.0 [110.7]	84.3 [91.6]	[]: Power Boost
		kgf	14,700 [15,960]	12,200 [13,250]	10,400 [11,290]	8,600 [9,340]	
		lbf	32,410 [35,190]	26,900 [29,210]	22,930 [24,890]	18,960 [20,590]	
	ISO	kN	151.0 [164.0]	125.5 [136.3]	106.9 [116.0]	87.3 [94.7]	
		kgf	15,400 [16,720]	12,800 [13,900]	10,900 [11,830]	8,900 [9,660]	
		lbf	33,950 [36,860]	28,220 [30,640]	24,030 [26,080]	19,620 [21,300]	

Note : Boom weight includes arm cylinder, piping, and pin
Arm weight includes bucket cylinder, linkage, and pin

STANDARD / OPTIONAL

ENGINE	STD	OPT
Cummins B4.5	●	
HYDRAULIC SYSTEM		
Electric Positive Flow Control (EPFC)	●	
3-Power Mode, 2-Work Mode, User Mode	●	
Variable Power Control	●	
Pump Flow Control	●	
Attachment Mode Flow Control		●
Engine Auto Idle	●	
Electronic Swing Parking Brake	●	
Engine Auto Shutdown Control	●	
Electronic Fan Control	●	
Hyundai Bio Hydraulic oil (HBHO)		●
CAB & INTERIOR		
ISO Standard cabin		
Rise-Up Type Windshield Wiper	●	
Radio / USB Player	●	
Handsfree Mobile Phone System with USB	●	
12V Power Outlet (24V DC to 12V DC converter)	●	
Electric Horn	●	
All-Weather Steel Cab with 360° Visibility	●	
Safety Glass - Tempered Glass	●	
Safety Glass - Laminated Glass, Front Window & Glass		●
Sliding Fold-In Front Window	●	
Sliding Side Window (LH)	●	
Lockable Door	●	
Hot & Cool Box	●	
Storage Compartment	●	
Ashtray & Cigar Lighter		●
Transparent Cabin Roof-Cover	●	
Sun Visor	●	
Door And Cab Locks, One Key	●	
Mechanical Suspension Seat With Heater	●	
Pilot-Operated Slidable Joystick	●	
Console Box Height Adjust System	●	
Automatic climate control		
Air Conditioner & Heater	●	
Defroster	●	
Starting Aid (Air Grid Heater) for Cold Weather	●	
Centralized monitoring		
8" LCD Display	●	
Engine Speed or Trip Meter / Accel.	●	
Engine Coolant Temperature Gauge	●	
Max Power	●	
Low Speed / High Speed	●	
Auto Idle	●	
Overload warning with alarm		●
Check Engine	●	
Air Cleaner Clogging Indicators	●	
ECO Gauges	●	
Fuel Level Gauge	●	
Hyd. Oil Temperature Gauge	●	
Fuel Warmer	●	
Warnings	●	
Communication Error	●	
Low Battery	●	
Clock	●	
Cabin Lights		●
Cabin Front Window Rain Guard		●
Cabin Roof-Steel Cover		●
Seat		
Adjustable Air Suspension Seat With Heater		●
Cabin FOG (ISO 10262) Level 2		
FOG (Falling Object Protective Structure) - ISO 10262 Level 2		●
Cabin ROPS		
ROPS (Roll Over Protective Structures) - ISO 1211 7-2	●	

MEMO

SAFETY	STD	OPT
Lifting Mode	●	
Proportional Auxiliary Hydraulic System		●
Battery Master Switch	●	
Rearview Camera		●
AAVM (Advanced Around View Monitoring)		●
Four Front Working Lights (2 Boom Mounted, 2 Front Frame Mounted)	●	
Travel Alarm	●	
Rear Work Lamp		●
Beacon Lamp		●
Automatic Swing Brake	●	
Boom Holding System	●	
Arm Holding System	●	
Safety Lock Valve For Boom Cylinder With Overload Warning Device		●
Safety Lock Valve For Arm Cylinder	●	
Swing Lock System		●
Three Outside Rearview Mirror	●	
Front Guard - Wire Net		●
ATTACHMENT		
Booms		
5.65 m, 18' 6" Mono	●	
5.65 m, 18' 6" 2-Piece		●
Arms		
2.0 m, 6' 7"		●
2.4 m, 7' 10"		●
2.92 m, 9' 7"	●	
3.9 m, 12' 10"		●
OTHER		
Removable Clean-Out Dust Net For Cooler	●	
Removable Reservoir Tank	●	
Fuel Pre-Filter	●	
Fuel Warmer	●	
Self-Diagnostics System	●	
Hi MATE (Remote Management System)		●
Batteries (2 × 12 V × 100 AH)	●	
Fuel Filler Pump (50 lpm)		●
Single-Acting Piping Kit (Breaker, Etc.)		●
Double-Acting Piping Kit (Clamshell, Etc.)		●
2 way Proportional RCV & Pedal control selection		●
Rotating Piping Kit		●
Air Compressor		●
Quick Coupler Piping		●
Quick Coupler		●
One Pedal Straight Travel System		●
Accumulator For Lowering Work Equipment	●	
Pattern Change Valve (2 Patterns)		●
Fine Swing Control System		●
Tool Kit		●
UNDERCARRIAGE		
Lower Frame Under Cover (Additional)		●
Lower Frame Under Cover (Normal)	●	
Track Shoes		
Triple Grousers Shoes (500 mm, 20")		●
Triple Grousers Shoes (600 mm, 24")	●	
Triple Grousers Shoe (700 mm, 28")		●
Triple Grousers Shoe (800 mm, 32")		●
Triple Grousers Shoe (900 mm, 35")		●
Double Grousers Shoe (700 mm, 28")		●
Track Rail Guard	●	

* Standard and optional equipment may vary. Contact your Hyundai dealer for more information. The machine may vary according to International standards.
 * The photos may include attachments and optional equipment that are not available in your area.
 * Materials and specifications are subject to change without advance notice.
 * All imperial measurements rounded off to the nearest pound or inch.

MEMO

MEMO